



DURABUILT
WINDOWS & DOORS

Windows are the essence of the home.

They welcome the comforting warmth and glow of the sunlight inside, open up to embrace the fresh springtime air, and allow you to experience the beauty of the world around you. Vivacé pushes the limits on high-performance functionality, magnificent design, and ultimate beauty. Not to mention Vivacé's luxurious finishes, superior seal system, impeccable design details and clean lines, and steel reinforcement for large window wall capability.

Vivacé truly redefines the exceptional. 

Design

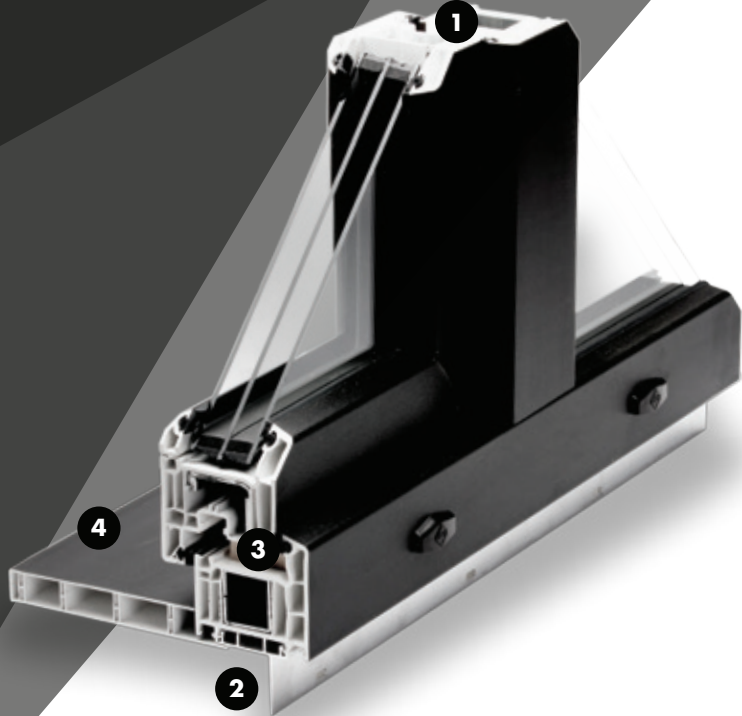

Vivacé

Large window wall capability, unique functionality, and sleek European design

1. Top-quality gaskets offer a dual compression seal for lasting performance
2. 2¾" vinyl frame and sash feature thick outer walls combined with dead air chambers, providing exceptional thermal values
3. Steel reinforcement uniquely designed to nest inside the largest chambers, allowing for oversized operators and large window wall configurations
4. Luxurious laminate finishes, inside and out



Hardware

Experience unparalleled security, durability, and simplicity with Vivacé's concealed steel alloy hardware

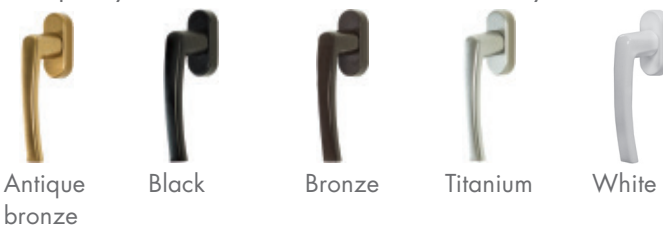

Design guidelines

Having your dream window fit its space shouldn't be a maybe thing. Vivacé has a diverse range of design and sizing possibilities, no matter the project or corner of your home.

Tilt Turn

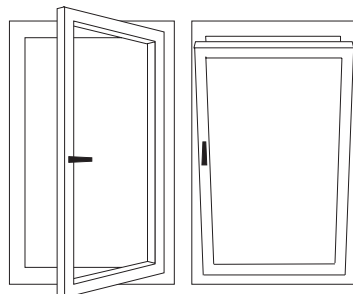

Venting sash open two ways; swinging in like a door or tilting from the top

Picture

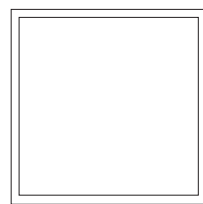

Opens up living space and maximizes the sunlight in your home

Shape

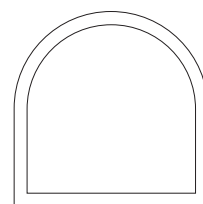

Choose from a variety of shapes that can easily be combined with other window types

Combination

Be your own designer by simply choosing your desired mix of ventilation and view

Colours, finishes, & trims

Add colour, transform your windows, and increase functionality with Vivacé's robust selection of finishes, trims, and hardware options. We especially love how the laminate finishes are weatherproof, combining both function and design. And since it's always great to have choices, mix and match within the entire spectrum of the Durabuilt family for optimal flexibility.

Laminate

Our high-performance laminate finishes are at home outdoors – and indoors. Combining function and design, they are both weatherproof and visually appealing.



VG fir



Beige

Black

Bronze

Brushed silver

Cocoa

Commercial brown

Graphite

Linen

Mahogany

Rojo oak

VG fir

Interior trims



Jamb extensions are available in vinyl, paint grade wood, and stain grade wood



½" and ¾" combo return easily accepts your choice of drywall or wood

Exterior trims



2" brickmould on all sides or with sloped sill. Mirrors the look of wood windows



Handy rebate flange to cover existing material



1½" brickmould on all sides for a slimmer appearance



3¼" exterior extender pushes the window back, creating a shadow box. Also ideal for ICF



1½" HD brickmould with nail fin. J-trim version available



Doors

Vivacé swing doors

What better way to make a positive statement while simultaneously securing your home against weather and intruders than with one of our wide range of swing doors? Choose from single or multiple unit doors, or even combine with Vivacé windows to create virtually any architectural design.

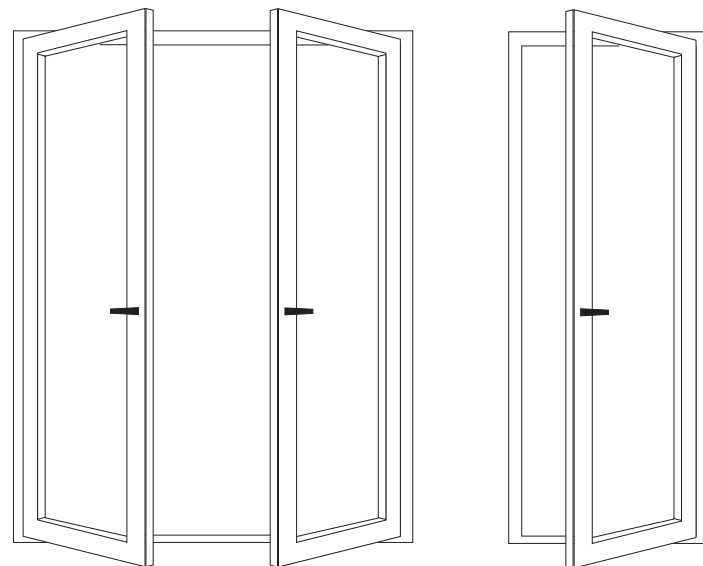

Vivacé tilt slide doors

With a simple turn of the handle the tilt slide doors operate in three positions: closed, tilt, and slide. An innovative runner mechanism means even large, heavy door units can be easily operated. The panel can tilt in at the top for safe ventilation, and when closed, the panel compresses against the frame for an incredibly tight seal.

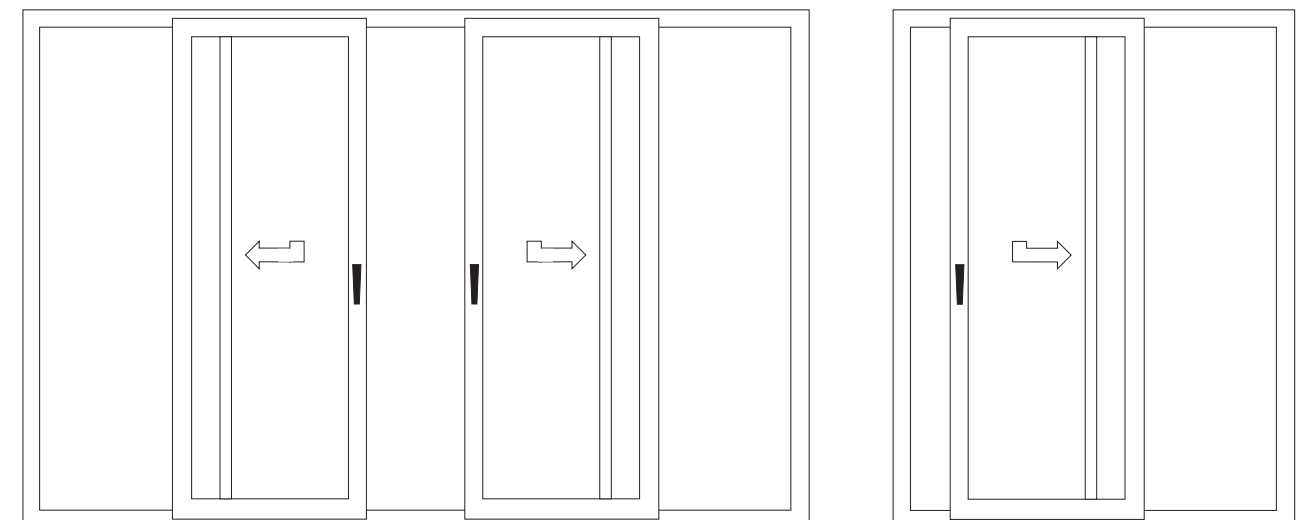



Details

Divided lites – SDL & GBG

Create unique architecture and infuse personality into your home with the look of divided lites. Options include placing a grille between the glass pane (GBG) or adhering simulated divided lites (SDL) to the interior and exterior of the glass. Whichever way you choose, the end result is nothing short of stunning.



Simulated divided lites

Available widths include 1", 1½", and 2¾" width

Exterior and interior finish will match your window finish choice



Grilles between glass

Available widths include 5/16", 5/8", and 1"

Colours



White



Beige



Black



Pewter



Commercial brown

Commercial brown and black are available in a split finish white interior in 5/8", and 1" widths



Glass & window performance



Triple pane



Low E

What would a Durabuilt window be without its real performance glass? Whether you choose triple pane, dual pane, or low-e solutions like Sungate or Solarban with argon fill, you'll receive superior performance and comfort requirements with the additional benefit of energy savings. Even better, for enhanced thermal efficiencies and reduced condensation, Durabuilt windows feature Super Spacer®, a premium all-foam, no metal spacer bar.

All Vivacé windows are tested to NAFS / CSA and Energy Star standards. Bottom line, our windows meet and exceed today's energy and structural requirements.





DURABUILT

WINDOWS & DOORS

Thank you for taking the time to explore Durabuilt. Our approach to windows is simple. We believe in innovation, operational excellence, and creating consumer connections. We understand that a home is more than just walls and windows; it's a place where memories are made, children grow, and worlds are shaped. That's why whether it's a renovation project or you're building a new home, we are committed to creating and providing the best solutions for you.

all about you.